



CLT

CROSS LAMINATED TIMBER



Pfeifer and Wood - a combination that has stood for quality and durability since 1948. As a family-run company, we think in terms of generations. This is precisely why we see change as a constant and actively and decisively meet new market needs. With the fascinating material CLT, we are building on the future with passion and conviction.

PASSION FOR TIMBER



If PFEIFER CLT panels are made in visible quality, they delight the residents with pleasantly warm wooden surfaces and become a visible expression of a contemporary attitude to life: living close to nature and sustainably.

Ecology & Economy combined

CLT – The massive potential of wood

Cross Laminated Timber (CLT) takes timber construction to a new level. The cross-glued wooden panels combine practical advantages such as a fast, dry and precise construction method with positive living characteristics and ecological unique selling points. This makes CLT the smartest technological advance since people build with wood. For today, for tomorrow and for many generations to come.

NEW DESIGN PERSPECTIVES

Wood can look back on a long history as a construction material. Its refinement into CLT opens up new dimensions in terms of bandwidth, height and aesthetics of architectural solutions. Thanks to the innovative solid wood product, the timber construction industry has been gripped by a special dynamic in recent years. Planners, architects and also investors recognize the potential to realize individual, flexible and above all high-quality projects with CLT. Trends such as modularization in urban architecture, combined with the increasing desire for natural materials,

contributed to the revival of timber construction. With its defined physical and mechanical properties, PFEIFER CLT offers the highest planning reliability and thus makes the work of architects and contractors much easier. PFEIFER CLT enables a future-oriented building architecture and combines aspects such as efficiency, naturalness, comfort and ecology.



*Wood is growing – more than is harvested throughout Europe.
Refined to PFEIFER CLT, wood is the most environmentally friendly material.*

THE ENTIRE SPECTRUM OF BUILDING CONSTRUCTION

Entire buildings in solid wood, sections in combination with other building materials or sophisticated interior design: PFEIFER CLT makes a contemporary and sustainable statement. The highly prefabricated panels prove themselves in a versatile range of applications from single-family houses to multi-storey buildings. The construction method with CLT has a special role to play in revitalization in rural and urban areas as well as in densification in conurbations, where it opens up new fields of action in urban construction with its comparatively low weight, precise prefabrication and dry execution. Wall, ceiling and roof elements can be flexibly combined with each other and used for low-, near-zero-energy and passive-energy buildings - in different sizes, building and roof shapes.

HIGH-PERFORMANCE CONSTRUCTION MATERIAL

The finished CLT system scores with a high degree of prefabrication, short construction time and easy assembly. In addition, the comparatively low component thickness provides additional space gain. The crosswise construction of the solid softwood plank layers creates high dimensional stability and enables biaxial load transfer, which is why the construction method is used even in earthquake-prone areas. The monolithic wooden panels meet all requirements in terms of fire protection, have a sound and heat insulation effect and guarantee solid construction has a high stability of value.

CLT also offers the best conditions for a film-free and diffusion-open wall structure. A comfortable and balanced indoor climate is created. The solid wood regulates the humidity of the room air, insulates in summer and serves as a heat accumulator in winter.

BUILDING WITH AN ECO-BONUS

In addition to the practical advantages, there are also important climate protection and environmental arguments in favor of the technology of formaldehyde-free glued solid wood components. In contrast to conventional building materials, wood grows back (more than is harvested throughout Europe!) and is a natural carbon store. By using wood products high amounts of CO₂ make an active contribution to climate protection. The raw material for the CLT comes from sustainable forestry, so forest owners are reliably supported in maintaining a healthy forest. If the construction method is correct in terms of building physics, the service life of a building made of solid wood is not limited to a certain time. Several hundred-year-old wooden farmhouses impressively testify to this constancy. At the end of its lifetime, PFEIFER CLT can easily be completely recycled or disposed of in an environmentally friendly manner. Another advantage: The low weight of PFEIFER CLT compared to concrete and steel facilitates transport and handling, which in turn saves energy and costs.

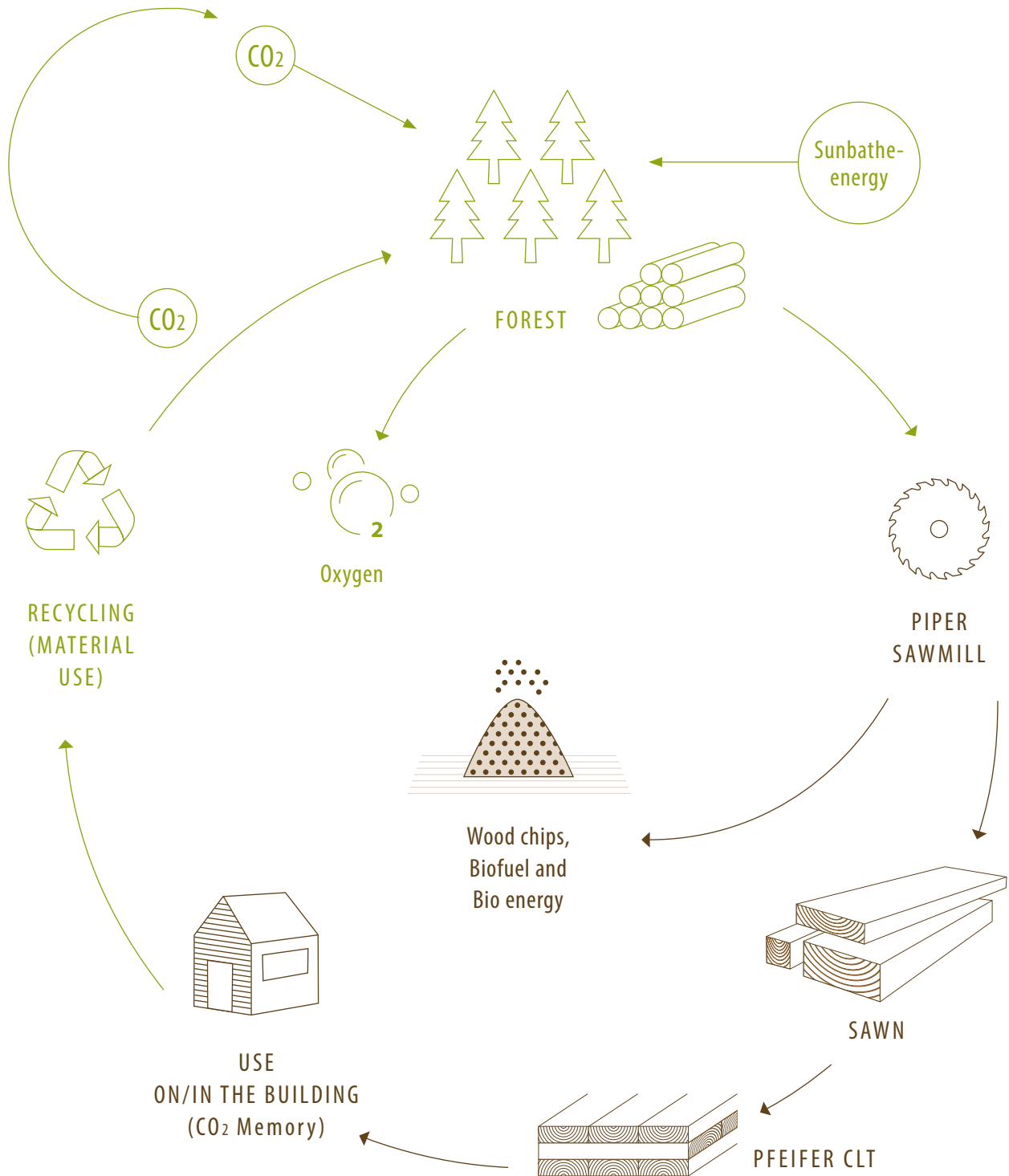

100% RECOVERY

The processing of the valuable raw material wood into PFEIFER CLT follows a closed recycling chain according to the cascade principle. Pfeifer completely processes logs from sustainably managed forests in Central Europe into a wide product portfolio. The use in structural timber construction increases the life cycle of the sawn timber and thus the climate protection-relevant CO₂-Binding significantly.

The future is building PIPER CLT

The universal genius of wood in building construction

CLT holds in all areas of application the building construction is moving in. Especially in municipal or commercial flagship projects and in multi-storey residential construction, complete or partial solutions with CLT ensure a fast and economical construction method. In addition, densification in conurbations is becoming more and more the topic of our time. Here, too, the prefabricated, dry construction method with short construction times and a comparatively light material offers enormous advantages over conventional building materials. In the single-family house, CLT raises the individual living quality to a new level. The holiday home in the hotel industry also benefits from the unique residential aesthetic features of PFEIFER CLT.

≡ **Municipal construction projects**

Efficiency with a feel-good character: municipal offices, schools, kindergartens, senior residences, intergenerational housing models, event, cultural or sports centers, ...

≡ **Commercial buildings / Office buildings**

Reputation and workplace quality: Company buildings, corporate headquarters and branches, office buildings, open-space models, modular workplace solutions, markets, logistics centers, ...

≡ **Residential buildings / Residential complexes**

When costs and speed count: single- and multi-storey buildings of any height, densification of any kind, housing estates, modular models, generational housing, social housing, a variety of urban planning solu-

tions, ...

≡ **Family home**

Individual architectural design options: single, double and terraced houses, partial or complete solutions with wall, ceiling and roof, visual quality, positive living climate and aesthetics, ...

≡ **Hotel industry**

From the guest house to the 5-star hotel village: the entire architectural spectrum in hotel construction, new construction, extensions, exterior and interior design, adventure living worlds, wellness landscapes, ...

≡ **Special constructions**

Fast and economical construction even with special requirements in building construction and interior design: garden sheds, towers, exhibition stands, furniture, constructions of all kinds, ...

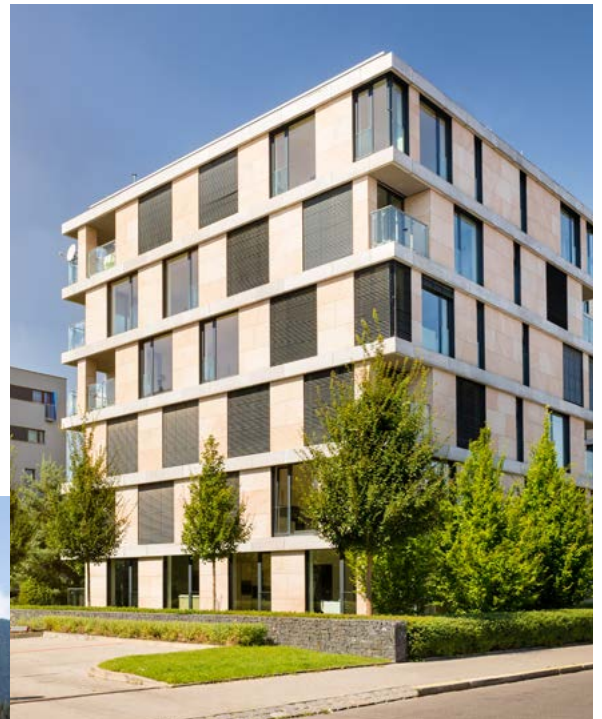

PFEIFER CLT builds on solid living quality

It's not just the appearance that counts

PFEIFER CLT impresses with its flexibility and versatility. While in practice it meets the highest structural and aesthetic requirements, it also protects the budget and the environment.



ARCHITECTURE

PFEIFER CLT offers almost unlimited possibilities in terms of construction concept, style and architecture and is absolutely compatible with other building materials. The solid wood panels are suitable for interior and exterior walls as well as for ceilings and roofs (no grid necessary).

SHORT CONSTRUCTION TIME

The prefabricated PFEIFER CLT panels are delivered by truck directly to the construction site, where the construction company assembles them easily, quickly and dry.

SOUNDPROOFING

Due to the relatively large mass, PFEIFER CLT elements in combination with corresponding superstructures have a very good air and impact sound behavior.

RADIATION

With the correct execution of the electrical installations, the absorbing properties of PFEIFER CLT provide increased protection against electromagnetic radiation.

EARTHQUAKE-PROOF

The high rigidity of the PFEIFER CLT elements, in conjunction with suitable fasteners, enables a highly earthquake-resistant construction.

PLANNING SECURITY

Defined or standardized mechanical and structural-physical properties of PFEIFER CLT system prefabricated parts allow maximum planning reliability.

LIVING QUALITY

PFEIFER CLT elements are open to diffusion. Thus, film-free constructions are possible, which, together with appropriate winter and summer thermal protection, ensure a pleasant and balanced indoor climate all year round.

FIRE PROTECTION

PFEIFER CLT elements are characterized by high fire resistance (fire resistance class REI 30-90). Unlike other building materials, wood burns safely and predictably.

SPACE SAVING

Due to the comparatively slim wall and ceiling structures that are possible with CLT elements, it is actually possible to gain net living space.

SUSTAINABLE

At the end of a building's lifetime, the natural raw material PFEIFER CLT can be recycled completely ecologically.

PFEIFER CLT build up the whole house

Components & Solutions

The crosswise gluing of the board layers turns the directional material wood into a highly solid building material with a panel or pane effect. This can be used to create space as a wall, ceiling or roof component, but also as a base plate and special component. Planners and contractors can work flexibly with component solutions and formats in order to make targeted use of the respective advantages.

Base

- ≡ CLT raw panels

Standard / System

- ≡ Standard panels (formatted)
- ≡ Bearing panels
- ≡ CLT system ceiling
- ≡ Ribbed elements
- ≡ Box elements
- ≡ Wood-concrete composite elements

Individual

- | | | |
|---|--|---|
| <p>Wall</p> <ul style="list-style-type: none"> ≡ Interior and exterior walls (load-bearing/non-load-bearing) ≡ Stiffening wall panels ≡ Apartment partitions ≡ Building partitions | <p>Cover</p> <ul style="list-style-type: none"> ≡ False ceiling ≡ Apartment dividers ≡ CLT system ceiling ≡ Platforms/Balconies ≡ Cantilevered areas | <p>Roman rooftops</p> <ul style="list-style-type: none"> ≡ Flat roof ≡ Canopies/cantilevered roof elements |
|---|--|---|

Special components

The versatility of the CLT material opens up completely new possibilities for creative, aesthetic solutions and inspires the imagination of planners. Pfeifer is the right partner and supplier of high-quality components for individual areas of appli-

cation. The CNC-controlled joinery basically sets no limits to the shape of a component made of cross laminated timber.

A few examples

- ≡ CLT beams / wall-like beams
- ≡ Point-based constructions
- ≡ Furniture construction
- ≡ Facade elements
- ≡ Moduls

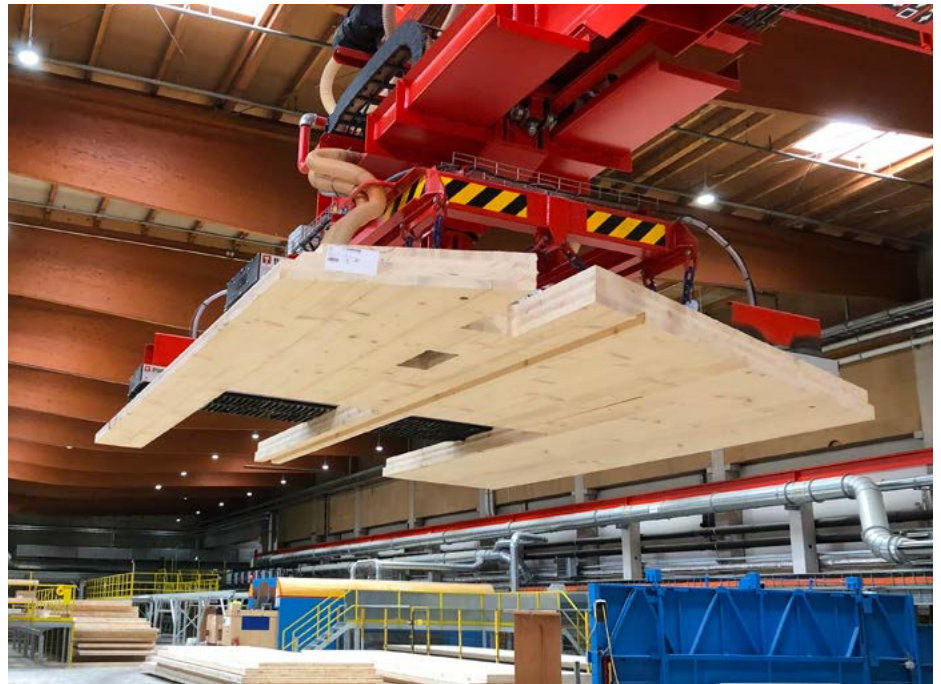

WALL

PFEIFER CLT wall elements meet all static, structural and fire protection requirements. The wall elements, which have been completely set up in the factory, including cut-outs for windows, doors and installations, are delivered to the construction site ready-made. So a CLT wall has it "in itself".

Benefits

- + Can be used as exterior wall, interior wall and apartment partition wall
- + Biaxial load-bearing effect: High vertical load-bearing is possible. High horizontal load absorption for building reinforcement
- + Economical use in multi-storey residential and industrial buildings
- + High degree of prefabrication with all openings and outlets
- + Dry construction
- + Wood-visual quality of living for a visual and tactile feel-good atmosphere
- + High flexibility in combination with other building materials

CEILING

The design of floor ceilings with PFEIFER CLT scores with the self-supporting and dry construction method. Large-sized, dimensionally stable components create a pane effect and can be mounted with finished visible surfaces for comfort and living quality. All standards regarding statics, fire and sound insulation are met.

Benefits

- + Biaxial load-bearing effect: Load-bearing effect can be used ideally when adding to the inventory
- + Seamless installation, no larger shrinkage joints
- + High degree of prefabrication
- + Dry construction
- + High heat storage mass in winter / insulator in summer
- + Finished visible surfaces = finished floor covering or finished ceiling soffit

ROOF (FLAT ROOF/ SLOPED ROOF)

In principle, any roof shape can be made with CLT. Roof constructions made of PFEIFER CLT meet all static, fire protection and sound engineering requirements. The excellent thermal insulation and storage properties of wood ensure a pleasant living climate - in winter as well as in summer.

Benefits

- + Biaxial load-bearing effect: cantilevers and breakthroughs in new dimensions
- + Large spans despite slim and light constructions
- + High degree of prefabrication
- + Quick rainproofness due to quick installation within a few hours
- + Dry construction
- + High heat storage mass in winter / Insulator in the summer
- + Finished visible surfaces inside / pleasant wooden surfaces for comfort

PFEIFER CLT builds on the latest standards

Technical data

PFEIFER CLT meets all the requirements for the structural timber construction. Find out more about the specific product characteristics and production method.



A product portrait of CLT

PFEIFER CLT is a large-format solid wood panel consisting of 3 to 15 layers of crosswise glued wood slats. Dried, strength- and quality-sorted, planed wooden slats made of European softwood and formaldehyde-free polyurethane (PU) adhesive are used.

Product designation

PFEIFER CLT Cross laminated timber

Application

Admission: 20/0023

Load-bearing and non-load-bearing components in buildings and wooden structures such as walls, ceilings or roofs

Class of use

NKL 1 and 2 (according to EN 1995)

Plate construction

3 to max. 15 crossed and glued layers (standard: 3 to 7 layers)

Layer variation

max. 3 fiber-parallel layers (≤ 90 mm) possible

Plate Length: up to 14.50 m

Plate width: up to 3.10 m

Plate thickness: 60 - 280 mm (standard), up to 320 mm on request

Lamella thicknesses

20, 30 or 40 mm

Strength class Raw material

C24; a proportion of max. 10% C16 is permissible (acc. EN 338)

Surface

Industrial Quality (IQ), Industrial Visual Quality (ISQ) and Residential visual quality (WSQ)

Timber species

European. Softwood

Wood moisture

$12 \pm 2\%$ (at the time of delivery)

Dimensional stability

≡ Lengthwise and crosswise in panel plane: 0.01 % per% change in wood moisture

≡ Perpendicular to the plate plane: 0.20% per% change in wood moisture

Adhesive

Polyurethane (PU) adhesive (formaldehyde-free) for finger jointing and surface gluing (acc. EN 301 or EN 15425)

Weight

approx. 480 kg/m³ (for determining the transport weight)

Diffusion resistance

μ = about 60 (at $u = 12 \pm 2\%$)

Air tightness

Class 4 (acc. EN 12207) Airtight from 3 layers acc. Report HFA v. 29.11.2019

Thermal conductivity

$\lambda = 0.12$ W/(m.K)

Specific heat capacity

$c_p = 1600$ J/(kg.Can)

Reaction to fire

D-s2, d0 (according to EN 13501)

Fire resistance / burn-off rate

~ 0.7mm/min. (for rough calculations)

Recycling

Waste code: 17 02 01 (according to AVV)

Formaldehyde class: E1 Equalizing concentration 0.01ppm (acc. Report HFA no. DLR 500038/2021 of 11.10.2021)

Basic principle of panel build-up

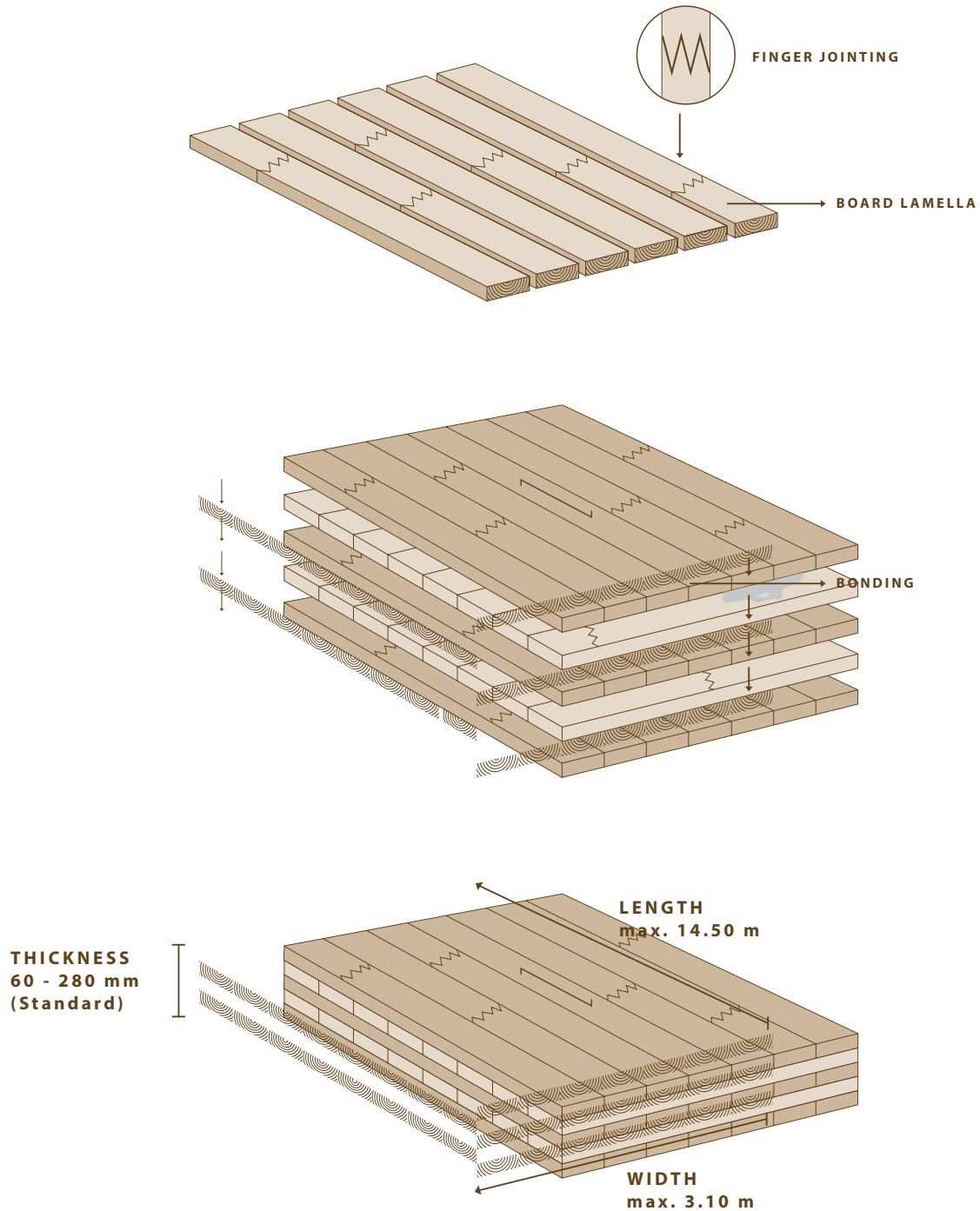

Further explanations on the principle and structure of a PFEIFER CLT Panel
 You can find PFEIFER CLT plate on pages 18/19.

*production method:
How a PFEIFER CLT panel is created*

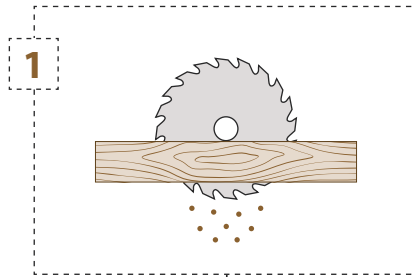

SAWN

Coniferous wood is cut in the forest and processed into boards in our own Pfeifer sawmill.

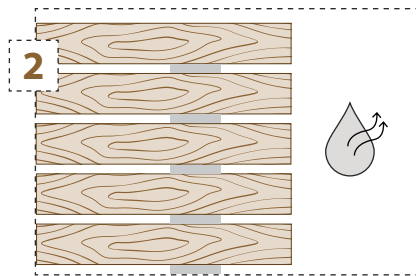

DRYING

Softwood boards are first technically dried to a wood moisture content of about 12% for over 48 hours at a temperature of more than 55 ° C and then pre-planed.

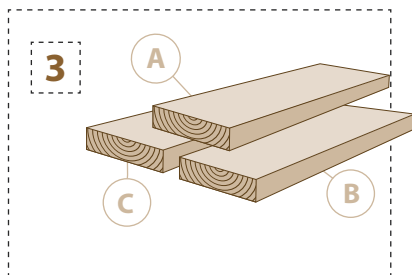

SORT

The pre-planed and technically dried boards are sorted by machine according to strength. For the top lamellae of the components, special sorting criteria are taken into account for higher surface qualities, which go beyond the criteria for a pure strength sorting.

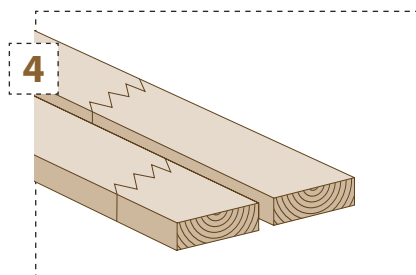

FINGER JOINTING & SLAT PLANING

Board sections discovered during sorting with strength-reducing or unsightly growth deviations, such as large branches, resin galls and bark inclusions, are processed depending on the strength and Surface class, capped out on a case-by-case basis. By means of a finger-shaped, non-positive adhesive connection (finger-jointed connection), the individual boards become, in principle, endlessly long slats in the longitudinal direction encounter. The endless slats are planed to the desired thickness.

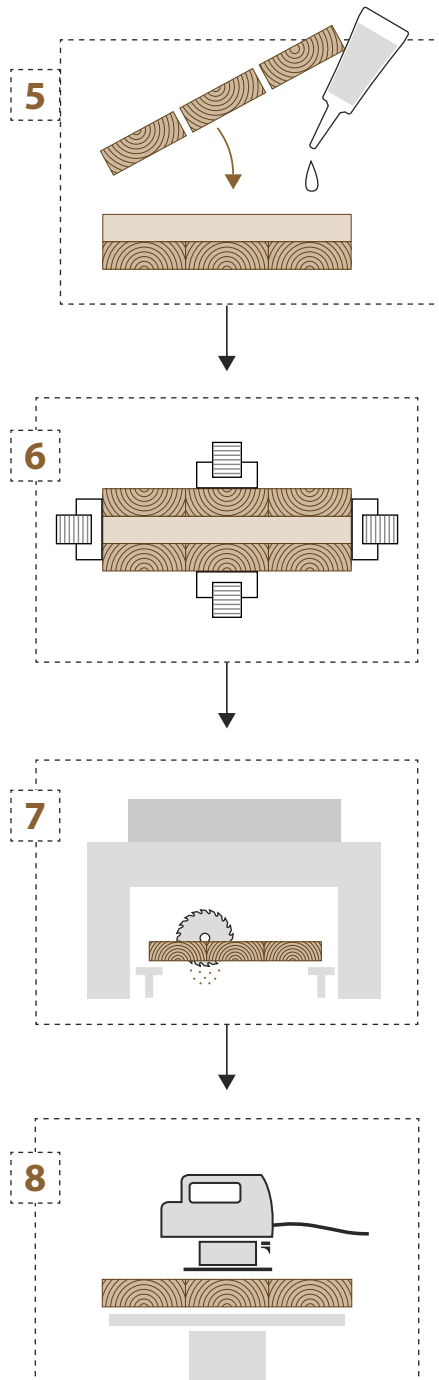
**GLUING**

The slats are laid out flat and glued in layers.

PRESSING

The pressing pressure is applied by means of hydraulic presses. The Pfeifer press also exerts pressure on all sides to minimize the joints between the board slats.

ABBUND

If necessary, jointing works can be carried out. These include format cuts, door and window cutouts, folds, holes, openings, etc.

COSMETICS + SANDING (FOR VISUAL REQUIREMENTS)

Finally, the cosmetic finishing is done. Here, defects are repaired with wood patches. The plates are then ground in a grinding plant with a visual requirement.

PFEIFER CLT builds on standardization

Standard superstructures

The orientation principle:

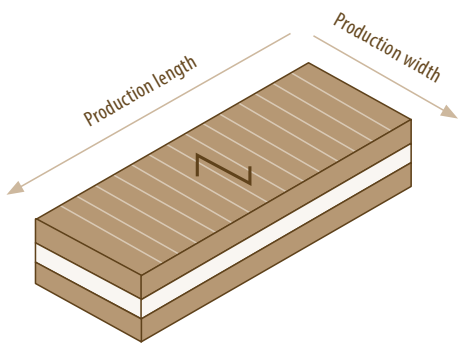

EXAMPLE:

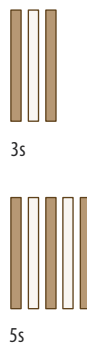

TRANSVERSE TOP LAYER

Top layers in the transverse direction of the plate (DQ) are mainly used for wall elements. Their bearing direction is vertical. As standard, DQ plates consist of three to five layers. Production widths: up to 3.10 m.

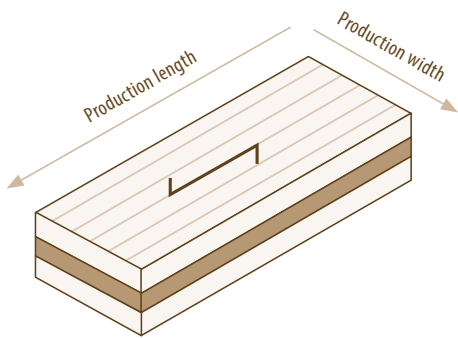

EXAMPLE:

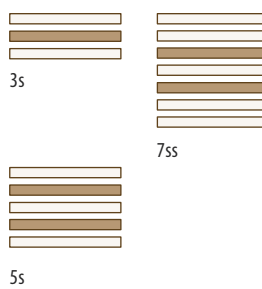

LONGITUDINAL TOP LAYER

CLT panels with top layers along the panel (DL) are used primarily for ceiling and roof elements. Their bearing direction is horizontal. As a rule, they consist of three to seven layers. Production lengths: up to 14.5 m.

The grain direction of the outer layer is also the load bearing direction. By using double layers, i.e. fiber-parallel top layers (ss), the longitudinal or transverse stiffness or the load-bearing capacity of the plate can be increased in a targeted manner. Also, a targeted change in the panel structure increases the fire resistance. If visual requirements are met, a uniform appearance can be achieved by adjusting the structure. PFEIFER CLT up to 15 layers of crosswise glued wooden slats are conceivable and permitted.

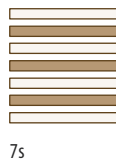

PFEIFER		GRAIN DIRECTION	BUILD-UP	THICKNESS	LENGTHS	INVOICED WIDTHS	WEIGHT*
CLT			[MM]	[MM]	[M]	[M]	[KG/M2]
60	3s	Top layer possible longitudinally or transversely DQ/DL	20-20-20	60	8.00 m up 14.50 m	2.45 to 3.10 m in 5 cm increments	28,8
80	3s		30-20-30	80			38,4
90	3s		30-30-30	90			43,2
100	3s		30-40-30	100			48,0
110	3s		40-30-40	110			52,8
120	3s		40-40-40	120			57,6
100	5s		20-20-20-20-20	100			48,0
120	5s		30-20-20-20-30	120			57,6
140	5s		40-20-20-20-40	140			67,2
150	5s		40-20-30-20-40	150			72
160	5s		40-20-40-20-40	160			76,8
180	5s		40-30-40-30-40	180			86,4
200	5s		40-40-40-40-40	200			96,0
180	7s		30-20-30-20-30-20-30	180			86,4
200	7s		20-40-20-40-20-40-20	200			96,0
220	7s		30-30-30-40-30-30-30	220			105,6
240	7s		30-40-30-40-30-40-30	240			115,2
260	7s		30-40-40-40-40-40-30	260			124,8
280	7s		40-40-40-40-40-40-40	280			134,4
180	7ss		30-30-20-20-20-30-30	180			86,4
200	7ss		30-30-30-20-30-30-30	200			96,0
220	7ss		30-30-30-40-30-30-30	220			105,6
240	7ss		40-40-20-40-20-40-40	240			115,2
260	7ss		40-40-30-40-30-40-40	260			124,8
280	7ss		40-40-40-40-40-40-40	280			134,4
300	8ss		40-40-30-40-40-30-40-40	300			144,00
320	8ss		40-40-40-40-40-40-40-40	320			153,60
290	9ss		30-30-10-30-30-30-10-30-30	290			139,20
300	9ss		30-30-40-30-40-30-40-30-30	300			144,00
300	9ss		40-40-20-40-20-40-20-40-40	300			144,00
310	9ss		40-40-20-40-40-40-20-40-40	310			148,80
320	9ss		40-40-20-40-40-40-20-40-40	320			153,60
320	9ss	40-40-30-40-20-40-30-40-40	320	153,60			

Further build-ups are possible on request.

* Calculated at 480 kg/m³

Top layers consist of two longitudinal layers

PFEIFER CLT builds on vision

Surface qualities

Wood is a natural product that swells and shrinks with changing moisture content. Careful technical drying counteracts this effect. PFEIFER CLT is made with a wood moisture of 12% +/- 2% to minimize the formation of cracks or joints. Due to high-quality processing, the material achieves a special product quality. The wooden panels are available in several optical categories for different purposes, whereby all panels are ground with a visual requirement. The sorting of the individual slats is carried out on the basis of defined criteria.



	INDUSTRIAL (IQ)	INDUSTRIAL VISIBLE (ISQ)	RESIDENTIAL (WSQ)
APPLICATION RANGE	purely structural components for subsequent covering (e.g. with plasterboard or 3-ply panel)	visible components in subordinate areas, e.g. in commercial and industrial structures or which are seen from a greater distance (e.g. canopies), can only be used to a limited extent in residential areas	visible components, especially for the living areas. But also in the kindergardens, schools and office areas. Treatment of the surface (on site) recommended (e.g. with varnish, UV protection, ...)
DEMANDS ON THE SURFACE	no visual demands on the surface, purely strength-oriented features (C24) with isolated joints, dropouts in the top layer, glue punctures as well as individual pressure points and soiling can occur, discolorations (e.g. blue stain) possible, glue puncturing possible	medium surface requirements, increased optical criteria for the cover lamellas, individual narrow joints, limited discolorations (e.g. blue stain) are possible	high standards, special requirements with regard to a homogeneous surface appearance and lamella quality, occasionally low/ slight discoloration possible, without blue stain
PRODUCTION NOTES	Finger joint can be seen in cover lamellas, without narrow side bonding	Finger joint connection can be seen in cover lamellas, to avoid subsequent shrinkage cracks, without narrow side bonding.	Finger joint connection can be seen in cover lamellas, in order to avoid subsequent shrinkage cracks, without narrow side bonding.
CHAMFER	without chamfer	Chamfer (approx. 5 mm) for DL plates (at the component edges), DQ without chamfer	Chamfer (approx. 5 mm) for DL plates (at the component edges), DQ without chamfer
PROCESSING OF THE SURFACE AT THE FACTORY	Slats planed, sanded only on request, cross-grinding possible with DQ plates	sanded over the entire surface (on one or both sides); sanding might be possible with DQ plates	sanded over the entire surface (on one or both sides); sanding might be possible with DQ plates
SURFACE TREATMENT AT THE FACTORY	not possible	not possible	possible with external partners on request
WOOD MOISTURE (CA.) im Delivery status	12 +/- 2 %	12 +/- 2 %	12 +/- 2 %
IN CRACKS JOINT	Wood is a natural product, therefore: As in all constructive solid wood products, cracks and joint formations due to the shrinkage to the later compensation moisture in the state of use are product-specific and cannot be avoided. A narrow side bonding does not take place.		

- Details:
- Visual surfaces should always be sampled: Contact us
 - Exact criteria (e.g. branch sizes, ...) of the surface variants: on request or under www.pfeifergroup.com
 - Surface qualities are possible on one or both sides; the optical criteria do not apply to the narrow/end faces and CNC edges
 - For WSQ surfaces, a change of the panel build-up may be required

Step by step to top quality

Project execution from a single source

Pfeifer customers benefit from competent contact persons and an established service culture around the product in every project phase. Quotation, order processing, loading and delivery on the construction site just-in-time form a complete package that customers can rely on.

A computer-optimized project process, state-of-the-art production facilities and experienced experts in sales, technical department, production and logistics ensure cost- and time-efficient project execution. Here is an overview of the competence spectrum.

OUR OFFER



Each CLT project has individual requirements, which are already taken into account in the consultation and quotation calculation. Technically trained employees strengthen the classic field service of the Pfeifer Group in order to be able to provide more in-depth advice if necessary. The technical department also supports the sales team with its know-how for individual project consulting. The tailor-made quotation and order processing is carried out as far as possible with IT support by means of a specialized CAD and ERP system. For larger projects and more complicated planning, a network of specialized partner offices is used.

The essential parameters for the quotation calculation are:

- ≡ Amounts
- ≡ Plate construction
- ≡ Quality
- ≡ Abbund
- ≡ Transport/Logistics
- ≡ Additional products and services



OUR MISSION

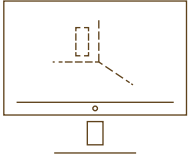

Immediately after placing the order, we reserve a corresponding production capacity. In the work preparation and order processing, the order information and planning documents of the customers are prepared for the order in production. In addition, Pfeifer employees generate release plans in the form of individual part drawings for the customer, generate the control of the joinery system and, among other things, already create the loading planning.

Close coordination and communication with the customer is an important part of this process step. Our IT system works across the interface from production to logistics and thus efficiently reduces additional effort.

The entire production process is also controlled by the integrated IT

The technical office and production work closely together. EDP-supported processes guarantee efficiency.



OUR PRODUCTION

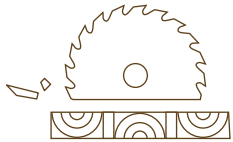

system and uses all optimization options from the management of the raw material to the packaging of the finished CLT sheets. The complex production is once again divided into individual processes (see the individual steps of the production process on pages 18/19):

- ≡ Lamella sorting
- ≡ Finger jointing
- ≡ Planing
- ≡ CLT-Plate coating and bonding
- ≡ Pressing
- ≡ Abbund
- ≡ Cosmetics & Sanding

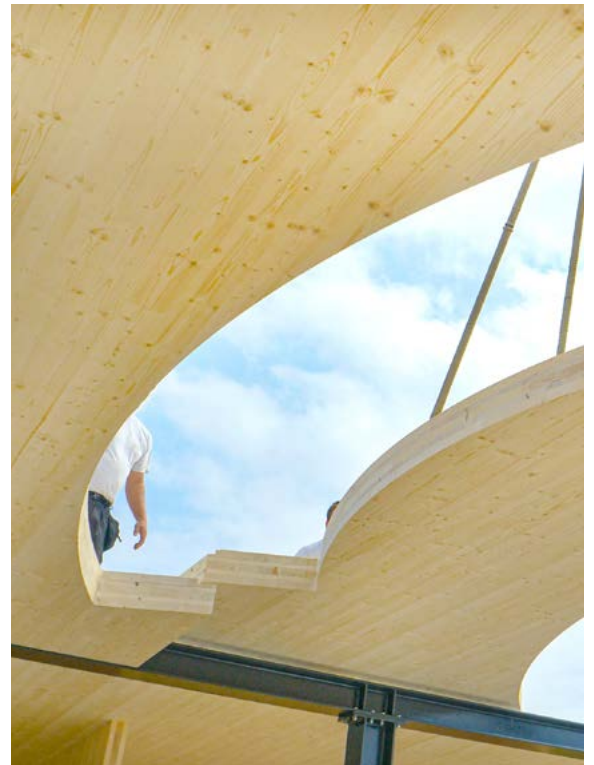

OUR LOGISTICS

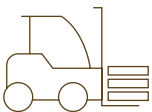

The best CLT record is useless if it is not in the right place at the right time. Due to the individual organization and coordination of the logistics process between the plant and the customer, the finished PFEIFER CLT is usually delivered just-in-time directly from our logistics partners to the construction site.

An entire hall equipped with a semi-automatic crane is available at the Schlitz site for picking, packaging and loading. The IT system records and automates individual plates, packages and entire loads. Pfeifer always guarantees the most economical type of loading, taking into account fast and efficient unloading on the construction site. To protect against environmental influences, all PFEIFER CLT panels and elements are of course protected by a resistant, UV-impermeable film and corresponding covers.

The corresponding electronically recorded loading documents and documents keep the customer informed about his order and the delivery.



PFEIFER CLT builds on security

Certificates

PFEIFER CLT is an approved and tested construction product, the production of which is subject to strict internal and external controls. These ensure high-quality and safe construction with PFEIFER CLT. The raw material for the refined wood panels comes from sustainable forestry.



*Scan the QR code to get
to the current certificates*

MASTHEAD

Publisher: Pfeifer Timber GmbH, Fabrikstraße 54, A-6460 Imst Design &

Layout: West Werbeagentur, A-6460 Imst

Editorial office: Agency Polak, A-6460 Imst

Photo Front page: © shutterstock.com ; alexandre zveiger



Further quality products of the Pfeifer Group



Glued laminated timber

Decades of know-how and the constant further development of this versatile precision material make Pfeifer one of Europe's leading manufacturers. Glued laminated timber elements in various cross-sections and lengths are used in solid timber construction in the roof, ceiling and wall.

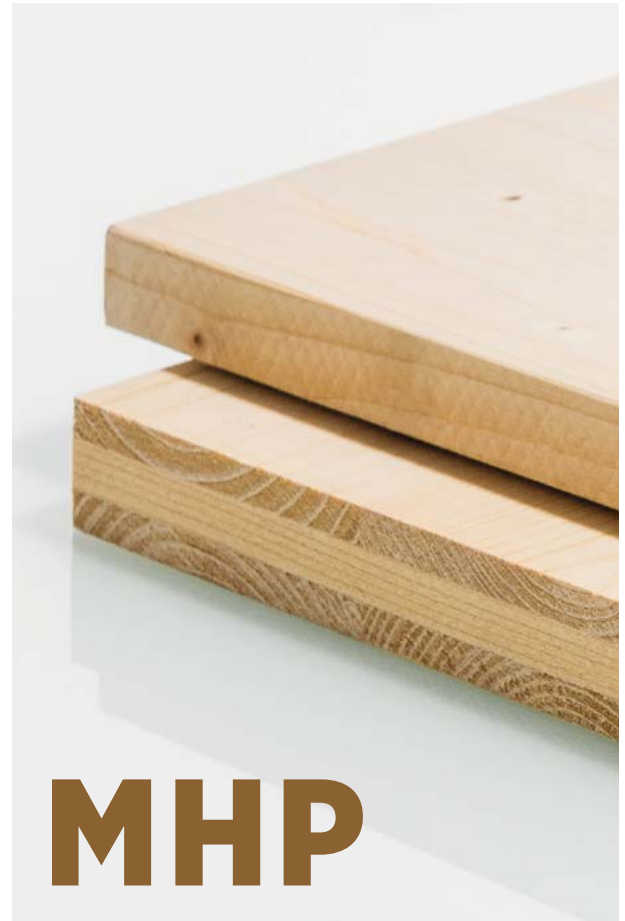

Solid wood panels

Single- and three-layer solid wood panels demonstrate their aesthetic, economic and ecological advantages in modern furniture construction, interior design and structural timber construction. The innovative product variant with tongue and groove allows a particularly quick and easy installation.

Pfeifer Timber GmbH

Factory Street 54 · A-6460 Imst

Tel.: +43 5412 6960 0

Fax: +43 5412 6960 200

info@pfeifergroup.com

www.pfeifergroup.com

From the heart of Europe
ALL OVER THE WORLD

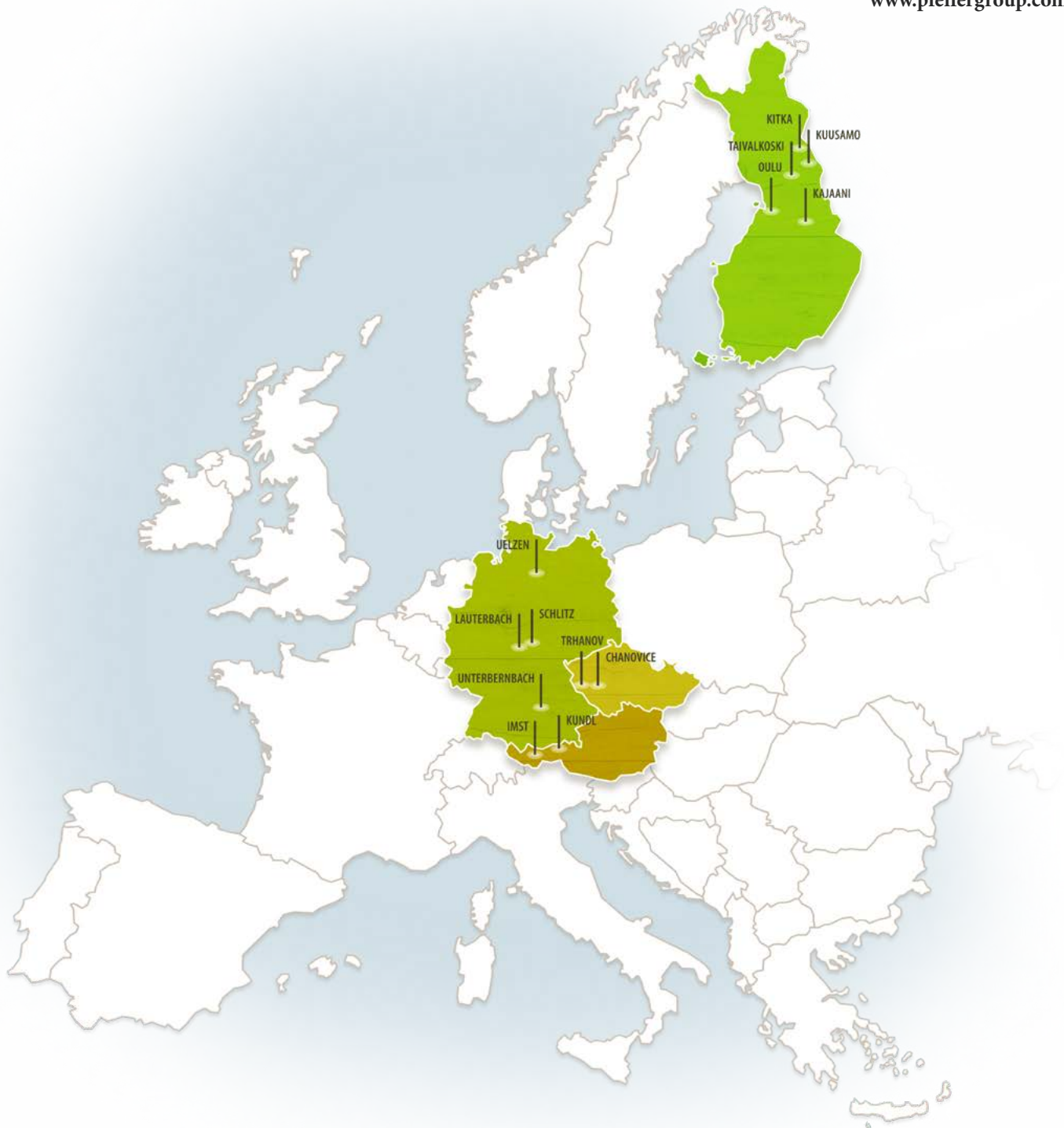

pfeifergroup.com